

# AQUA COOLER®

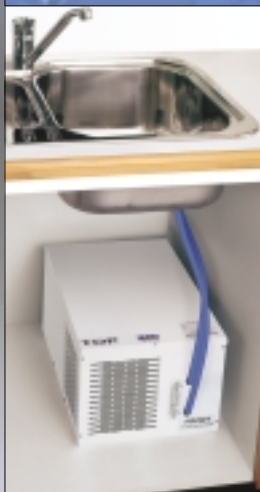
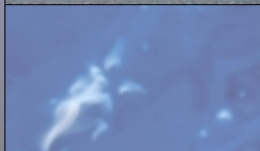
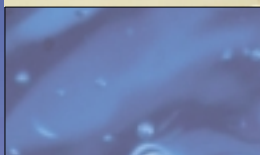

# UB SERIES

## UNDER BENCH DRINKING WATER COOLERS

### MODELS

- UB1 – 8 LITRES PER HOUR
- UB2 – 15 LITRES PER HOUR
- UB3 – 5 LITRES PER HOUR

## FEATURES

- “Out of sight” water coolers.
- Ideal for installation in kitchen cupboards.
- Fully automatic operation.
- Easily connected to most filter systems.
- Robust construction.
- Optional glass filler available.

### AQUA COOLER PTY LIMITED

14-16 MARJORIE STREET  
SEFTON NSW 2162  
AUSTRALIA

TELEPHONE (612) 9743 9233

FACSIMILE (612) 9743 9244

EMAIL [sales@aquacooler.com.au](mailto:sales@aquacooler.com.au)  
[coolers@aquacooler.com.au](mailto:coolers@aquacooler.com.au)

INTERNET [aquacooler.com.au](http://aquacooler.com.au)

# AQUA COOLER®

### WATER RESERVOIR

All models have a chilling chamber to meet peak usage periods. The tanks are fabricated from hard drawn, seamless copper which is tin plated for your safety.

- UB1 – 0.8 litre tank, 8 litres per hour
- UB2 – 1.5 litre tank, 15 litres per hour
- UB3 – 0.8 litre tank, 5 litres per hour

### REFRIGERATION

All use R143a refrigerant gas which is non-toxic, non-flammable and environmentally friendly. The refrigerant flow is controlled by a capillary tube, which has no moving parts. A suction line is fitted to provide maximum heat exchange.

### WATER CONNECTIONS

- provided in the carton
- Water inlet – 6.2mm (1/4") OD Tube.
- Water outlet – 6.2mm (1/4") OD Tube.

### COMPRESSORS

- UB1 – 1/8 hp nominal capacity
- UB2 – 1/5 hp nominal capacity
- UB3 – 1/16 hp nominal capacity

### THERMOSTAT CONTROL

Each thermostat is factory pre-set for optimum performance.

### ELECTRICAL

All models are 240 volts, 50Hz power supply and are fitted with a 2 metre house cable and 3 pin plug.

### PERFORMANCE TO ARI 1010-94 STANDARD

- Water Inlet – 26.7°C
- Water Outlet – 10°C
- Ambient Air – 32.2°C.

### WEIGHT - PACKED

- UB1 – 15kg
- UB2 – 21.5kg
- UB3 – 13kg

### DIMENSIONS

- UB1 – 315mm wide x 365mm high x 415mm deep
- UB2 – 340mm wide x 535mm high x 440mm deep
- UB3 – 315mm wide x 187mm high x 415mm deep

### OPTIONAL EXTRAS

Z-3019 Glass Filler for fitment to sink.

### NOTE

It is recommended that all products be vented to allow maximum air flow over the compressor. The UB2 has a vent included in the carton.



DISTRIBUTED BY

# UB SERIES

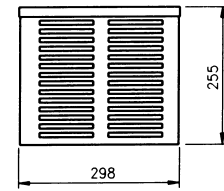
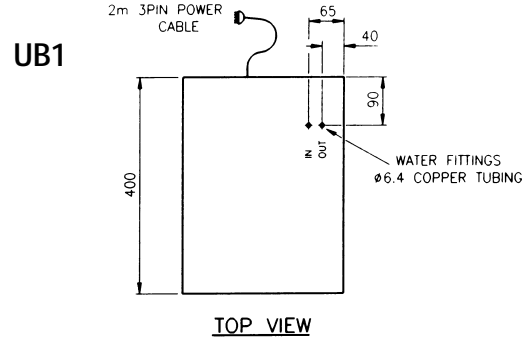

UNIT SUPPLIED WITH WATER CONNECTIONS

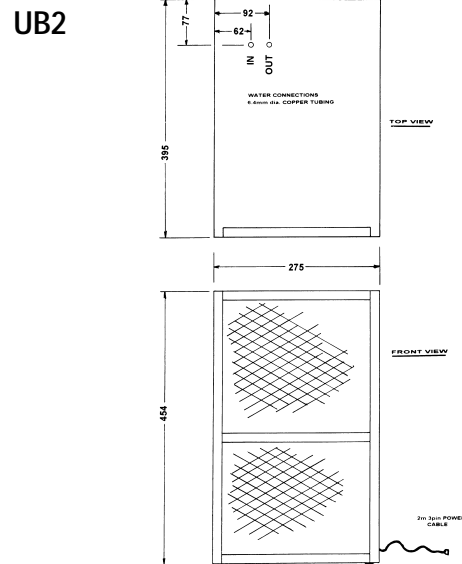

UNIT SUPPLIED WITH VENT & WATER CONNECTIONS

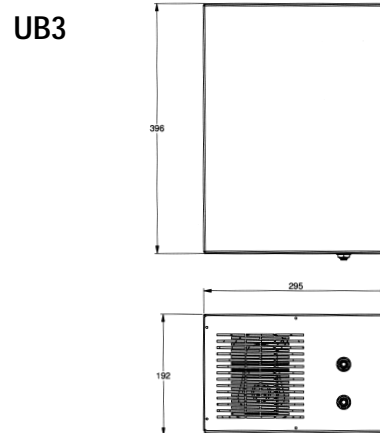

UNIT SUPPLIED WITH WATER CONNECTIONS